

REASONING

8ER14

Marking the test
and understanding performance



117627



Llywodraeth Cymru
Welsh Government

Marking the reasoning test

This document comprises:

- the markscheme for the National Numeracy Test (Reasoning) for Year 8 together with marking guidance
- additional information to support teachers' understanding of their learners' responses, providing a platform for growth.

All items within this test require numerical reasoning and therefore most are open, allowing the learner to select what they consider to be an appropriate strategy. This means that there may be a range of ways of arriving at a solution.

As a consequence, marking the reasoning tests may not be as straightforward as simply checking whether or not the final answer is correct since the methods used are also of importance.

Understanding the markscheme

To ensure the accessibility of the markscheme, the focus is primarily on key pointers that indicate the learner's understanding. For example, the markscheme may state 'Shows the value **12**' or 'Links **36** to **9**'.

These values generally credit intermediate stages, showing partial understanding.

Alongside this, commentary is provided as appropriate, to enable markers and teachers to understand their learners' responses and also to support marking.

Common errors are also flagged up, as well as explanations as to why certain responses are awarded partial credit.

Exemplars

To help schools not only with marking but also in interpreting their learners' responses, a range of exemplars is provided for each item, as appropriate.

These exemplars are actual responses from learners (taken from a trial of the reasoning tests) so include spelling mistakes and numerical inaccuracies. They have been typed to ensure anonymity.

Assessing and building on test performance

Marking the test gives teachers an overall score for each learner.

However, this score in isolation is unlikely to provide a great deal of information relating to the strengths of individual learners, or evidence of those areas of numerical understanding and reasoning skills that require improvement.

Equally, comparing learners' scores may mask significant differences in their performance. For example, two learners may both score 12. However, within that overall score Learner A may show a clear ability to communicate effectively but need support to review their work, while Learner B may show the exact opposite.

For this reason, the markscheme and the accompanying materials are designed to provide teachers with a deeper assessment of both individual and class performance.

Diagnostic tool

To assist in interpreting and building on test performance, a diagnostic tool is provided.

This can be accessed via learning.wales.gov.uk

At its simplest level, the diagnostic tool provides markers with a check on the total score for that particular learner.

However, completing the full set of data on each learner gives the teacher an overview of class performance, identifying group or individual strengths and problem areas and hence indicating further teaching needs.

Building on the test: classroom activities

Having assessed learners' ability to apply numerical reasoning and identified areas for both individual and class development, teachers may then wish to build on the test experience and materials through accessing learning.wales.gov.uk

This site provides the test items and associated markschemes, but also includes additional materials with suggestions for linked classroom activities to extend the learning.

In addition, further activities supporting the teaching and learning of numerical reasoning can be found on learning.wales.gov.uk

Markscheme

General marking rules

It is essential that you apply this markscheme, the marking guidance and the general marking rules given below to your own marking, in order for the standardised scores to be valid.

- The marking guidance shown within the markscheme should be applied to find the relevant score for each question. No half marks are awarded.
- At the end of each double-page spread of marking, record the total number of marks in the 'total' box in the bottom right-hand corner. Check that the mark recorded does not exceed the maximum number of marks available.
- Once the marking has been completed, add up the total number of marks awarded. This is the total score and should be recorded on the cover of the test booklet and input onto the relevant mark sheet on the school's management information system, together with the details and date of the test taken.
- Markers should record their initials on the cover of the test booklet to assist quality assurance.

This data should then be submitted as part of the National Data Collection (NDC). Further details are available from the *National Reading and Numeracy Tests – 2014 test administration handbook* on the Learning Wales website and in *National Data Collection and reporting arrangements 2013/14* available on the Welsh Government website.

Marking guidance

It is important that the tests are marked accurately. The questions and answers below help to develop a common understanding of how to mark fairly and consistently.

Must learners use the answer boxes?

Provided there is no ambiguity, learners can respond anywhere on the page. If there is more than one answer, the one in the answer box must be marked, even if incorrect. However, if the incorrect answer is clearly because of a transcription error (e.g. 65 has been copied as 56), mark the answer shown in the working.

Does it matter if the learner writes the answer differently from that shown in the markscheme?

Numerically equivalent answers (e.g. eight for 8, or two-quarters or 0.5 for half) should be marked as correct unless the markscheme states otherwise.

How should I mark answers involving money?

Money can be shown in pounds or pence, but a missing zero, e.g. £4.7, should be marked as incorrect unless the markscheme states otherwise.

How should I mark answers involving time?

In the real world, specific times are shown in a multiplicity of ways so accept, for example, 02:30, 2.30, half past 2, etc. Do not accept 2.3 as this is ambiguous. The same principle should be used for marking time intervals, e.g. for two and a half hours accept 2.5 but not 2.5pm.

What if the method is wrong but the answer is correct?

Unless the markscheme states otherwise, correct responses should be marked as correct even if the working is incorrect as learners may have started again without showing their revised approach.

What if the learner has shown understanding but has misread information in the question?

It is important that learners select the appropriate information and review their work. However, for most questions, method marks can still be obtained.

What should I do about crossed out work?

Working which has been crossed out and not replaced can be marked if it is still legible.

What is the difference between a numerical error and a conceptual error?

A numerical error is one in which a slip is made, e.g. within 86×67 the learner works out $6 \times 7 = 54$ within an otherwise correct response. A conceptual error is a more serious misunderstanding for which no method marks are available, for example if 86×60 is recorded as 516 rather than 5160

What if learners use a method that is not shown within the markscheme?

The markscheme shows the most common methods. However, there can be a wide range of approaches to a question and any correct method, however idiosyncratic, is acceptable.

In all questions, the correct answer should be given full marks, whatever the method used, unless the markscheme states otherwise.

Most questions give partial credit for responses that show a correct method but the answer is incorrect or incomplete: a correct method is one that would lead to a correct answer if there were no numerical errors.

8ER14 Reasoning test: Markscheme

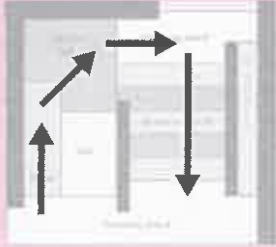
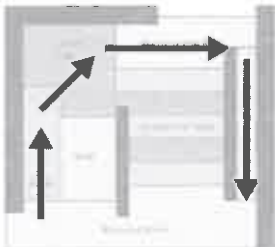
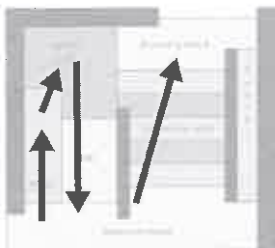
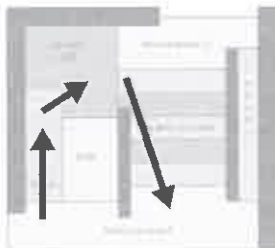
Q	Marks	Answer
1i	2m	<p>Shows all four key movements below, with direction of travel clearly shown</p> 
	Or 1m	<p>The only error is to omit direction of travel</p> <p>Or</p> <p>Their route starts at bouncing area A and is correct as far as bouncing area B, e.g.</p> <ul style="list-style-type: none">  <p>Or</p> <p>Their route finishes by going from one bouncing area to the other across the up and over walls, e.g.</p> <ul style="list-style-type: none">  <p>Or</p> <p>The only error is to omit bouncing area B, e.g.</p> <ul style="list-style-type: none"> 

Throughout, accept climbing up the slide rather than climbing up the ramp

Throughout, accept a change of direction on the middle up and over wall, e.g.

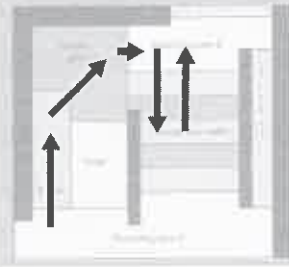

Question 1i: Exemplars

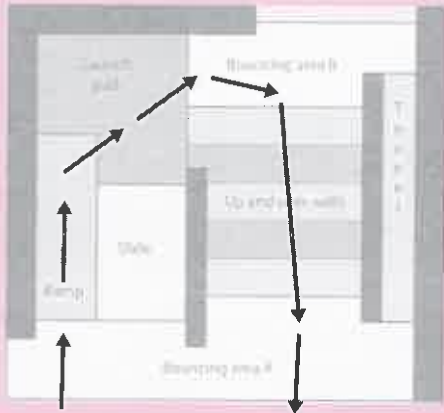

Correct; 2 marks

- The slight inaccuracy in starting and finishing just outside bouncing area A can be ignored.

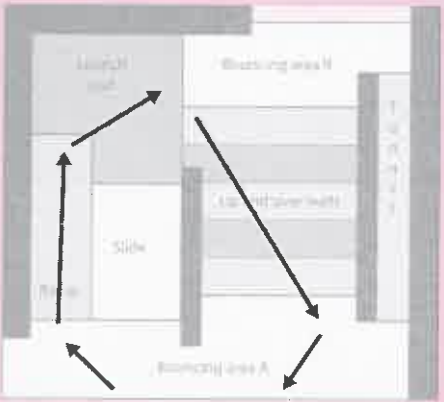

Bouncing area B omitted; 1 mark

- The positioning of the arrows suggests that this learner may well understand the correct route but because it is not explicit it cannot be credited.

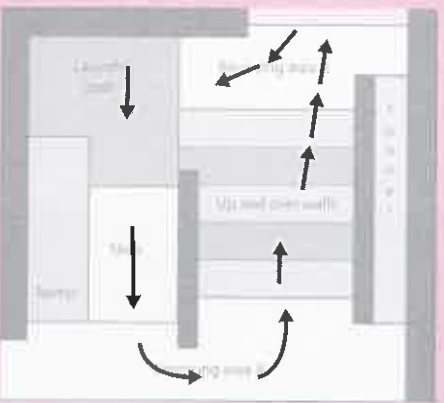



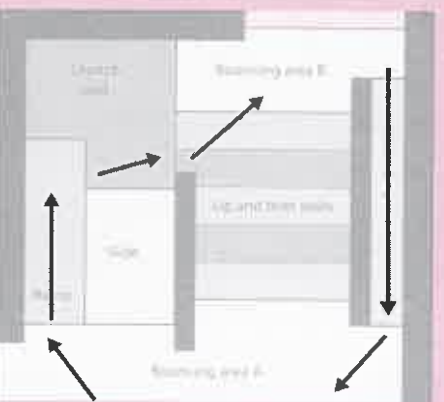

Route finishes via the up and over walls; 1 mark

- Because the first part of the route is incorrect, the second part crosses the up and over walls in the wrong direction. However, it shows correct interpretation of part of the graph so scores 1 mark.

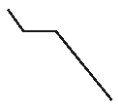

Incorrect; 0 marks

- Bouncing area B is accessed via the up and over walls so the first stage of the route is incorrect and cannot be awarded 1 mark.

Q	Marks	Answer
Use all four categories of this markscheme to give the total score		
1ii	1m	Draws stage 1 to show: bounces (minimum 1) → up (diagonal straight line) → horizontal straight line, e.g. • 
	1m	Draws stage 2 to show: down → horizontal straight line → down → horizontal straight line → down , e.g. •  Or (condone) down → horizontal straight line → down , e.g. • 
	1m	Draws stage 3 to show: bounces (minimum 1) → up → horizontal straight line → down → bounces (minimum 1), e.g. • 
	1m	Gains all three marks above, and there are no additional stages , and the launch pad is their highest point

Stage 1 links to

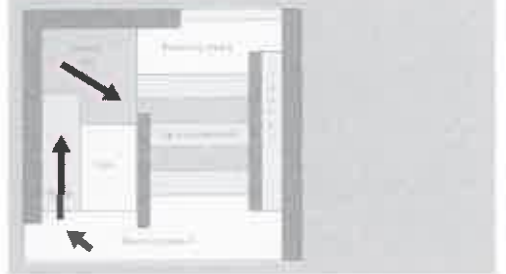

Stage 2 links to

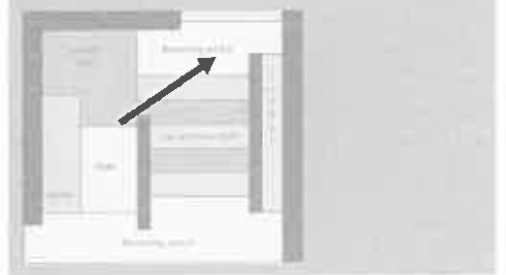

Stage 3 links to

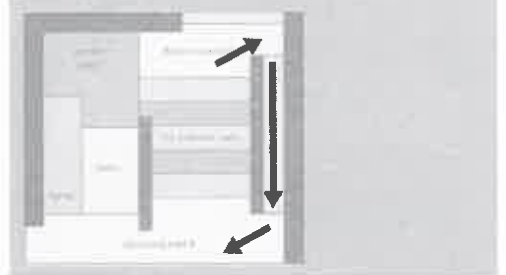

Do not accept a tunnel that has two horizontal lines, e.g.



Common error

Question 1ii: Exemplars

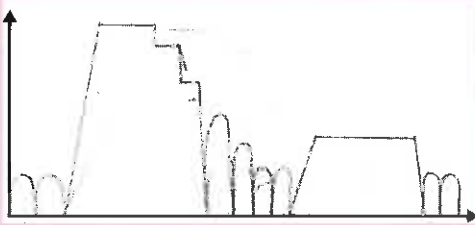

All correct; **4 marks**

- Stages 1, 2 and 3 are shown correctly; there are no incorrect stages and the launch pad is the highest point.



All correct; **4 marks**

- This learner has created a scale on the y-axis to show relative heights. This supports their thinking.
- Condone vertical lines shown in stage 3 rather than at an angle.

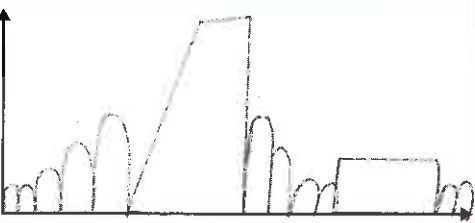

Stages 1 and 3 correct; **2 marks**

- Stage 2 is incorrect.

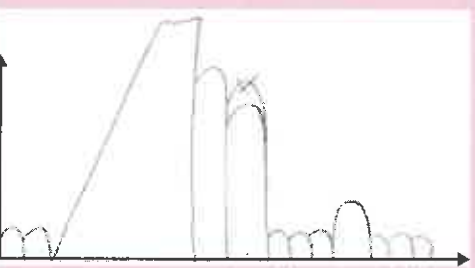

Stage 1 correct; **1 mark**

- Stage 2 is incorrect and stage 3 does not show straight lines to represent climbing up to and down from the tunnel.

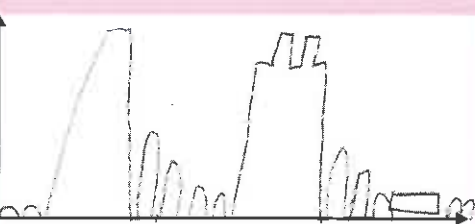

Stage 1 correct; **1 mark**

- Stage 2 is incorrect and stage 3 shows two horizontal lines for the tunnel.

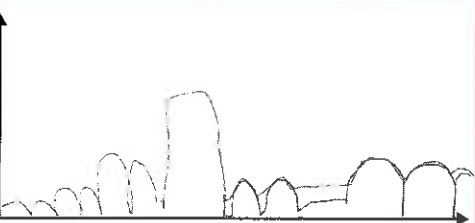

Stage 1 minimally acceptable; **1 mark**

Q	Marks	Answer
2	3m	£39
	Or 2m	Shows a clear intent to $\div 3$ and then double , e.g. <ul style="list-style-type: none"> • $58.5 \div 3 = 18.5$ (error) $18.5 + 18.5$ <p>Or</p> <p>Shows the fraction $\frac{2}{3}$ or equivalent</p>
	Or 1m	Shows 19.50 (or 19.5 or 1950) <p>Or</p> <p>Shows + 3</p>

◀ **Cost of one letter**

Question 2: Exemplars



$$\begin{array}{r}
 \pounds 19.50 \\
 + \pounds 19.50 \\
 \hline
 \pounds 19.50 \\
 + \pounds 58.50 \\
 \hline
 \pounds 78.00 \\
 \hline
 \pounds 39.00
 \end{array}$$

£ 39.00

Correct; **3 marks**

- This learner may have used a calculator to find the value £19.50 but has then worked with pen and paper methods. This may indicate a lack of understanding of what it means to show a method.



$$\begin{array}{r}
 \cancel{19.5 \div 35} \\
 1.4 \\
 58.50 \div 3 = \pounds 19.5 \times 2 = 97.5
 \end{array}$$

£ 97.5

Shows the intent to $\div 3$ and double; **2 marks**

- The method is correct but there is a slip when finding 19.5×2 . Common sense should have alerted the learner that the cost should not be greater than the original cost for 3 letters.



$$58 \div 3 = \cancel{19}$$

£ 38

Shows the intent to $\div 3$ and double; **2 marks**

- This learner has truncated the answer to $58 \div 3$, but as 19 doubled is 38 we can be confident that they understand the method.



$$58.50 \div 3 = 19.05$$

one letter costs £19.05
if you buy two letters it
would cost = £38.01

£ 38.01





Shows $\div 3$; **1 mark**

- This learner has misinterpreted the calculator display, linking 19.5 to 19.05 rather than 19.50. The same misconception may account for the total cost of £38.01 rather than £38.10 but as we cannot be sure we cannot be confident that the learner intends to double.







Q	Marks	Answer
3	2m	600 grams
	Or 1m	<p>Links $\frac{3}{4}$ (of the jar with jam) to 500g, e.g.</p> <ul style="list-style-type: none"> • $\frac{3}{4} = 500$ <p>Or</p> <p>Links the empty jar to 200g, e.g.</p> <ul style="list-style-type: none"> • None = 200 <p>Or</p> <p>Links $\frac{1}{4}$ (of the jam in a full jar) to 100g, e.g.</p> <ul style="list-style-type: none"> • It's gone up 100 which is a quarter

4	2m	360 cm
	Or 1m	<p>Links 20 to one side of a hexagon</p> <p>Or</p> <p>Shows a method that would lead to 360cm if calculated correctly, e.g.</p> <ul style="list-style-type: none"> • $120 \times 6 \div 2$ • 20×18

Question 3: Exemplars

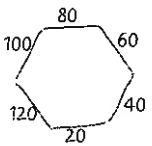
 <p>200g = Empty 300g = $\frac{1}{4}$ 400g = $\frac{1}{2}$ 500g = $\frac{3}{4}$ 600g = Full</p>  <p style="text-align: right;">600 grams</p>	<p>Correct; 2 marks</p> <ul style="list-style-type: none"> This learner uses their knowledge of fractions to reach the correct answer.
 <p>Because every time a $\frac{1}{4}$ of it comes up, it goes up a 100 grams</p> <p style="text-align: right;">700 grams</p>	<p>Correct statement; 1 mark</p> <ul style="list-style-type: none"> '$\frac{1}{4}$ of it comes up' refers to the change in mass. This is correctly linked to 100 grams.
 <p>every everytime adding 100g $\frac{3}{4} = 500$</p> <p style="text-align: right;">grams</p>	<p>Correct statement; 1 mark</p> <ul style="list-style-type: none"> 'Every time adding 100g' would not be creditworthy as it is not linked to $\frac{1}{4}$. However, $\frac{3}{4}$ is linked to 500 grams.

Question 4: Exemplars

 <p>each edge = 20cm x 18 edges = 360</p> <p style="text-align: right;">cm</p>	<p>Correct; 2 marks</p> <ul style="list-style-type: none"> This learner shows good understanding but would benefit from discussion as to why repeated use of the equals sign is incorrect.
  <p style="text-align: right;">600 cm</p>	<p>20 linked to one side; 1 mark</p>
 <p>each hexagon is 120 but there is only half of each one which is 70 and $70 \times 6 = 560$</p> <p style="text-align: right;">cm</p>	<p>Correct method; 1 mark</p> <ul style="list-style-type: none"> There are two numerical slips in this response but the method ($120 \div 2 \times 6$) would lead to 360
 <p style="text-align: right;">12.6 cm</p>	<p>Incorrect; 0 marks</p> <p> This learner has measured a side of the blue hexagon then used that measurement to find the total length. Understanding that diagrams are not to scale, unless told otherwise, is an important numerical skill.</p>

Q	Marks	Answer
5i	1m	94% (accept 93.75 but not 93)

5ii	2m	10																													
	Or 1m	<p>Shows $\frac{9}{10}$</p> <p>Or</p> <p>Shows $\frac{10}{11}$ then gives the answer 11</p> <p>Or</p> <p>Forms a correct equation, e.g.</p> <ul style="list-style-type: none"> $\frac{n-1}{n} \times 100 = 90$ <p>Or</p> <p>Shows at least two of the trials below, linking the SPF number to its percentage, even if it is not given to the nearest integer value (accept truncation)</p> <table border="1"> <thead> <tr> <th>SPF number</th> <th>%</th> <th>% to 2 decimal places</th> </tr> </thead> <tbody> <tr> <td>5</td> <td>80%</td> <td>80.00%</td> </tr> <tr> <td>6</td> <td>83%</td> <td>83.33%</td> </tr> <tr> <td>7</td> <td>86%</td> <td>85.71%</td> </tr> <tr> <td>8</td> <td>88%</td> <td>87.50%</td> </tr> <tr> <td>9</td> <td>89%</td> <td>88.89%</td> </tr> <tr> <td>10</td> <td>90%</td> <td>90.00%</td> </tr> <tr> <td>11</td> <td>91%</td> <td>90.91%</td> </tr> <tr> <td>12</td> <td>92%</td> <td>91.67%</td> </tr> <tr> <td>13</td> <td>92%</td> <td>92.31%</td> </tr> </tbody> </table>	SPF number	%	% to 2 decimal places	5	80%	80.00%	6	83%	83.33%	7	86%	85.71%	8	88%	87.50%	9	89%	88.89%	10	90%	90.00%	11	91%	90.91%	12	92%	91.67%	13	92%
SPF number	%	% to 2 decimal places																													
5	80%	80.00%																													
6	83%	83.33%																													
7	86%	85.71%																													
8	88%	87.50%																													
9	89%	88.89%																													
10	90%	90.00%																													
11	91%	90.91%																													
12	92%	91.67%																													
13	92%	92.31%																													

Question 5: Exemplars

93.75 %

What number on the front will block 90% of the sun's rays?

$$\frac{11}{12} \times 100 = 91.6 \text{ } 90\%$$

90%

Part i correct; **1 mark**

Part ii $\frac{9}{10}$ shown; **1 mark**

- This learner shows understanding, but because 10 has not been identified as the answer, only 1 mark can be given.

93.6 %

What number on the front will block 90% of the sun's rays?



$\frac{9}{10}$

Part i incorrect; **0 marks**

Part ii $\frac{9}{10}$ shown; **1 mark**

- Although this learner shows understanding that $90\% = \frac{9}{10}$, they do not relate back to the question being asked.

94 %

What number on the front will block 90% of the sun's rays?



10/11

Part i correct; **1 mark**

Part ii incorrect; **0 marks**

- Because the value 11 has not been identified as the answer, no credit can be given.

93 %

What number on the front will block 90% of the sun's rays?



$$\frac{17}{18} \times 100 = 94\%$$

$$\frac{14}{15} \times 100 = 93\%$$

$$\frac{13}{14} \times 100 = 92\%$$

$$\frac{11}{12} \times 100 = 91\%$$

11

Part i incorrect; **0 marks**

Part ii incorrect; **0 marks**

- In part ii, the first three trials should be ignored as the SPF must be lower than 14. Only one acceptable trial is shown so no credit can be given.
- Throughout, this learner truncates values. This could be a useful discussion point after the test.

Q	Marks	Answer
6	4m	Shows 28 and 25 and concludes that the first way (landscape) gives the greater number
	Or 3m	Shows 28 and 25 Or Shows 28 and 30 and concludes that the second way (portrait) gives the greater number
	Or 2m	Shows 28 Or Shows 25 Or Shows 4 × 7 and 5 × 5 (accept 5 × 6)
	Or 1m	Shows 4 × 7 Or Shows 5 × 5 (accept 5 × 6) Or Shows 4, 7, 5 and 5 (accept 4, 7, 5 and 6) Or Shows all four of 4.2 , 7.425 , 5.25 and 5.94 , even if rounded or truncated, and shows understanding of area by the use of multiplication

28 is from 4×7 , the number that can fit the first way (landscape)
25 is from 5×5 , the number that can fit the second way (portrait)

30 is from 5×6 , treating 297mm as if it were 300mm

4.2 is from $210 \div 50$,
7.425 is from $297 \div 40$,
5.25 is from $210 \div 40$ and
5.94 is from $297 \div 50$

Question 6: Exemplars

✂ 4 across 7 down 28
5 across 5 down 25
First

Shows 28 and 25, with landscape; **4 marks**

- Although the numerical communication is somewhat brief, this learner shows full understanding.

✂ $\frac{50}{50} = 4 \text{ —} = 28 \text{ pics}$
 $\frac{50}{7} = 7 \text{ |}$
 $\frac{210}{5} = 5 \text{ —} = 30 \text{ pics}$
 $\frac{210}{6} = 6 \text{ |}$
portrait will be the best

Shows 28 and 30, with portrait; **3 marks**

- This learner may think that it does not matter if the photographs are a few millimetres too small.

✂ $210 \div 40 = 5$ $\frac{210}{50}$ you could fit more in this one
 $297 \div 50 = 5$
 $50 \div 210 = 4$ $\frac{297}{40}$
 $40 \div 297 = 7$

Shows 4, 7, 5 and 5; **1 mark**

- No evidence is given as to why more can fit in when portrait.
- The second set of divisions are written in the incorrect order. This could form a useful discussion point after the test.

✂ $\frac{297}{40} = 7$
 $\frac{210}{50} = 4$ = 11 They will be the same
 $\frac{297}{50} = 6$ $\frac{210}{40} = 5$

Shows 4, 7, 5 and 6; **1 mark**

- Common Error** Although this learner starts correctly, they find the number of photographs by adding rather than multiplying.

✂ $297\text{mm} \div 50\text{mm} \updownarrow = 5.94$
 $297\text{mm} \div 40\text{mm} \updownarrow = 7.43$
 $210\text{mm} \div 50\text{mm} \leftrightarrow = 4.2$
 $210\text{mm} \div 40\text{mm} \leftrightarrow = 5.25\text{mm}$
 $5.94 + 5.25\text{mm} = 11.19\text{mm}$
 $7.43 + 4.2\text{mm} = 11.63\text{mm}$
Answer = 11.19mm

Incorrect; **0 marks**

- Although the first steps to the solution are shown, because the dimensions are added rather than multiplied, no credit can be given.

✂ 40 goes into ~~210~~ 297 6 times
50 goes into 210 4 times

50 goes into ~~210~~ 297 5 times
40 goes into 210 5 times

the 2nd one is best because it can fit 5 in, first one can only fit 4

Incorrect; **0 marks**

- Even though a calculator is available, there is an error in the first line. This shows the importance of checking work.